

B-B
1:15

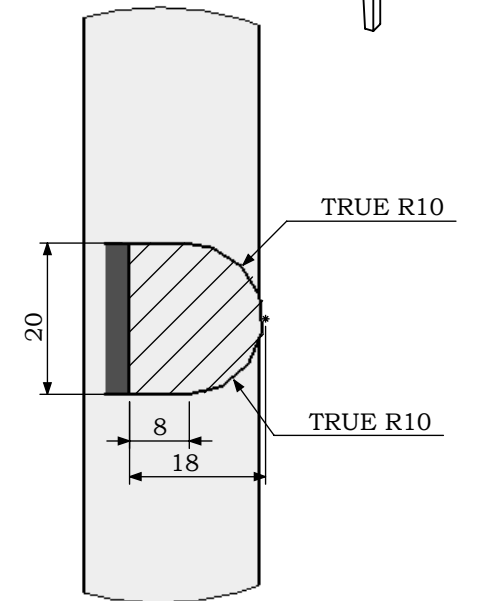

C-C
1:15

